

REVISIONS					
REV	DESCRIPTION	DRN	CHK	APPD	DATE
REV 00					

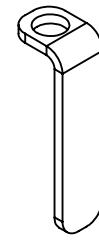

HINGE

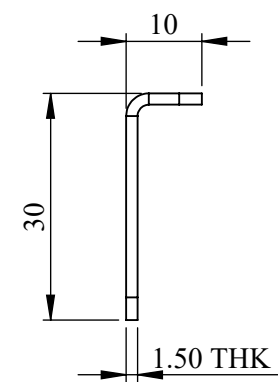
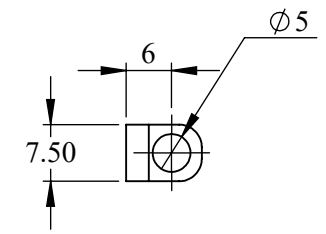

SLOTTED CHEESE HEAD SCREW

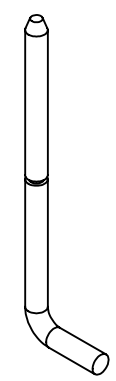
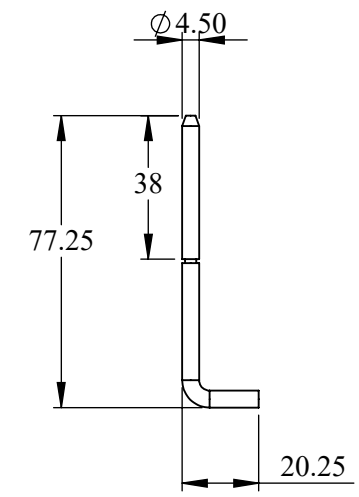
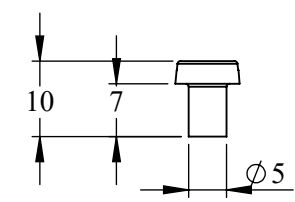
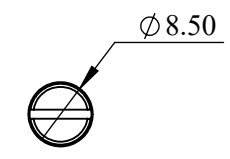
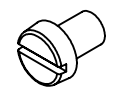

HINGE PIN

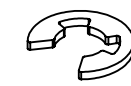

E CIRCLIP

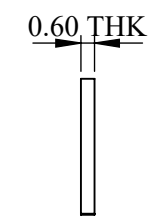
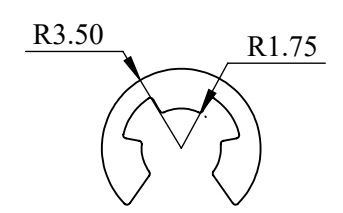

- NOTES - UNLESS OTHERWISE SPECIFIED:
1. FINISH: POWDER COATED - FRAME - 7035, ALL COVERS - 7016 (TEXTURE)
 2. DIMENSIONS ARE TO BE INTERPRETED AS PER ASME Y14.5M - 1994.
 3. ALL DIMENSIONS APPLY AFTER FINISHING.
 4. PART TO BE CLEAN AND FREE OF ALL SHARP EDGES BURRS, CHIPS, SHAVINGS AND OILS BOTH INTERNALLY AND EXTERNALLY.
 5. ALL BEND RADIUS AND RELIEFS TO BE MINIMUM.
 6. ALL DIMENSIONS ARE IN MM.
 7. UNLESS OTHERWISE SPECIFIED DIMENSIONS REFER DXF DRAWING.

SUPERSEDES:		NAME	DATE/SIGN																								
MATERIAL: CRCA		DRAWN	SUDHAGAR 02.07.2024																								
WEIGHT: 3.00G	THK: 2MM	CHK'D																									
FINISH: SEE NOTES		APPV'D	BALRAM																								
TOLERANCES UNLESS OTHERWISE SPECIFIED		STATUS: REV 00																									
<table border="1"> <thead> <tr> <th colspan="8">LINEAR DIMENSION</th> </tr> <tr> <th>0.5-3</th> <th>3-6</th> <th>6-30</th> <th>30-120</th> <th>120-400</th> <th>400-1000</th> <th>1000-2000</th> <th>2000-4000</th> </tr> </thead> <tbody> <tr> <td>±0.5</td> <td>±0.5</td> <td>±1</td> <td>±2</td> <td>±3</td> <td>±4</td> <td>±5</td> <td>±10</td> </tr> </tbody> </table>				LINEAR DIMENSION								0.5-3	3-6	6-30	30-120	120-400	400-1000	1000-2000	2000-4000	±0.5	±0.5	±1	±2	±3	±4	±5	±10
LINEAR DIMENSION																											
0.5-3	3-6	6-30	30-120	120-400	400-1000	1000-2000	2000-4000																				
±0.5	±0.5	±1	±2	±3	±4	±5	±10																				
<table border="1"> <thead> <tr> <th colspan="3">ANGULAR DIMENSION</th> <th colspan="3">EXTERNAL RADII & CH</th> </tr> <tr> <th>0-10</th> <th>10-50</th> <th>50-120</th> <th>120-400</th> <th>OVER 400</th> <th>0.5 - 3</th> <th>3 - 6</th> <th>OVER 6</th> </tr> </thead> <tbody> <tr> <td>±1°</td> <td>±0.30°</td> <td>±0.30°</td> <td>±0.10°</td> <td>±0.5°</td> <td>±0.2</td> <td>±0.5</td> <td>±1</td> </tr> </tbody> </table>				ANGULAR DIMENSION			EXTERNAL RADII & CH			0-10	10-50	50-120	120-400	OVER 400	0.5 - 3	3 - 6	OVER 6	±1°	±0.30°	±0.30°	±0.10°	±0.5°	±0.2	±0.5	±1		
ANGULAR DIMENSION			EXTERNAL RADII & CH																								
0-10	10-50	50-120	120-400	OVER 400	0.5 - 3	3 - 6	OVER 6																				
±1°	±0.30°	±0.30°	±0.10°	±0.5°	±0.2	±0.5	±1																				
THIRD ANGLE PROJECTION:																											

Fuji Electric

DOC TYPE: MECHANICAL DRAWING

PRODUCT: 12-15KVA SCVS DM DG

TITLE: HINGE

DWG NO: RCAB02584R0-03_03

SIZE: A3

1:10 4 OF 6